

CE



BlueWave[®] AX-550 V2.0

All-in-One, Large-Area LED
Flood System User Guide

 **DYMAX[®]**

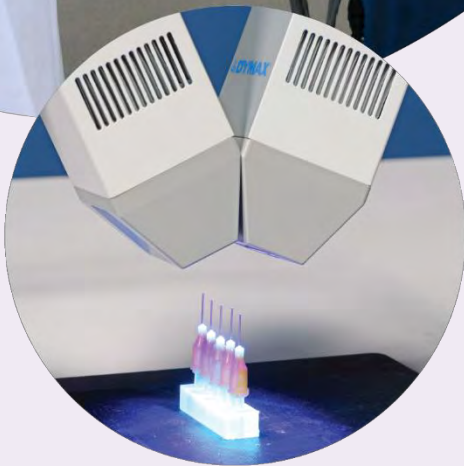

About Dymax

UV/Visible light-curable adhesives. Systems for light curing, fluid dispensing, and fluid packaging.

Dymax manufactures industrial, light-curable, epoxy, and activator-cured adhesives. We also manufacture a complete line of manual fluid dispensing systems, automatic fluid dispensing systems, and light-curing systems. Light-curing systems include LED light sources, spot, flood, and conveyor systems designed for compatibility and high performance with Dymax adhesives.

Dymax adhesives and light-curing systems optimize the speed of automated assembly, allow for 100% in-line inspection, and increase throughput. System designs enable stand-alone configuration or integration into your existing assembly line.

Please note that most dispensing and curing system applications are unique. Dymax does not warrant the fitness of the product for the intended application. Any warranty applicable to the product, its application, and use is strictly limited to that contained in the Dymax standard Conditions of Sale. Dymax recommends that any intended application be evaluated and tested by the user to ensure that desired performance criteria are satisfied. Dymax is willing to assist users in their performance testing and evaluation by offering equipment trial rental and leasing programs to assist in such testing and evaluations. Data sheets are available for valve controllers or pressure pots upon request.

Contents

Introduction	4
Where to Get Help.....	4
Safety	4
Product Overview	5
Unpacking	6
Unpacking and Inspecting Your Shipment	6
Parts Included.....	6
System Installation	7
System Assembly.....	7
System Cooling	7
Wiring and Connections	8
Connections	9
PLC UV Control	14
Status Output.....	15
Operation	17
System Initialization.....	17
Rotary Pushbutton.....	17
System Initializing.....	18
Information	18
System Settings.....	19
Program Load/Save	23
Irradiation Setup.....	24
Irradiation in Production or Admin Mode	26
Irradiation in PLC mode.....	27
Maintenance	29
Product Cleaning.....	29
Emitter Replacement.....	29
Replace Fuse	30
Troubleshooting	31
Error Screen.....	31
Spare Parts & Accessories	33
Accessories.....	33
Components & Spare Parts	33
Specifications	34
Validation	36
Set Exposure Time, Determine Intensity	36
Set Intensity, Determine Exposure Time	36
Control	36
Declaration of Conformity	37
Warranty	39
Index	39

Introduction

This guide describes how to set up, use, and maintain BlueWave® AX-550 V2.0 LED flood-curing system safely and efficiently.

Intended Audience

This user guide is meant for experienced process engineers, technicians, and manufacturing personnel. If you are new to high-intensity LED light sources and do not understand the instructions, contact Dymax Application Engineering for answers to your questions before using the equipment.

Where to Get Help

Dymax Customer Support and Application Engineering teams are available by phone in the United States, Monday through Friday, from 8:00 a.m. to 5:30 p.m. Eastern Standard Time. You can also email Dymax at info@dymax.com. Contact information for additional Dymax locations can be found on the back cover of this user guide.

Additional resources are available to ensure a trouble-free experience with our products:

- Detailed product information on our website www.dymax.com
- Dymax adhesive product data sheets on our website
- Safety data sheets (SDS) provided with shipments of Dymax materials

Safety



WARNING! *If you use this UV light source without first reading and understanding the information in the UV Light Safety Guide, SAF001, injury can result from exposure to high-intensity light. To reduce the risk of injury, please read and ensure you understand the information in that guide before assembling and operating the Dymax UV LED light source.*

This device falls under IEC 62471 Risk Group 3 for UVA and Blue Light emissions:

WARNING! *UV emitted from this product. Avoid eye and skin exposure to unshielded products.*

WARNING! *Possibly hazardous optical radiation emitted from this product. Do not look at operating lamp. Eye injury may result.*

WARNING! *Under NO circumstances should the interconnect cable from the controller to the LED emitter be connected or disconnected while power to the unit is on. This procedure is usually called “hot swapping” and should not be performed as it could cause damage to the controller or the emitter. Always power down the equipment before disconnecting or connecting any of these devices.*

Product Overview

The BlueWave AX-550 V2.0 is a high-intensity LED flood system used for curing light-curable materials. The unit is designed to be integrated into a larger system, such as an automated manufacturing system, or used with a light shielding enclosure to create a bench-top curing station.

The BlueWave AX-550 V2.0 is an all-in-one system that incorporates an LED flood emitter and control system for manual and automated process applications. Dymax offers three different wavelength LED flood emitters: VisiCure® (405 nm), PrimeCure® (385 nm), and RediCure® (365 nm).

The controller portion includes the controller and power supply, which is designed to identify the type of emitter that is connected so the control portion of the system can be used with any of the three LED emitter configurations.

The BlueWave AX-550 V2.0 functions as a flood-curing system with a 125 mm x 125 mm (5 in x 5 in) irradiated curing area.

The unit can be operated in admin mode (unrestricted control) or production mode (restricted control) which allows for process management via access restrictions.

The unit can be controlled as well by Programmable Logic Controller (PLC) for automation applications.

LED technology within the BlueWave AX-550 V2.0 LED Flood System allows for instant on/off activation without the need for a warm-up period and is also rated for continuous operation.

Figure 1.
BlueWave AX-550 V2.0 LED Flood Curing System



Unpacking

Unpacking and Inspecting Your Shipment

Upon arrival, inspect all boxes for damage and notify the shipper of box damage immediately. Open each box and check for equipment damage. If parts are damaged, notify the shipper and submit a claim for the damaged parts. Contact Dymax so that new parts can be shipped to you immediately.

The parts below are included in every package/order. If parts are missing from your order, contact your local Dymax representative or Dymax Customer Support to resolve the problem.

Inspect the glass for any damage or residue on the surface. Carefully clean the glass with the alcohol swab. Take care not to touch the glass with bare hands, as any residue left on the window can adversely affect performance on the unit.

NOTE: The BlueWave AX-550 V2.0 power cord requires a snap-on EMI Filtering Ferrite Core located near the plug end of the cord. The ferrite core may be factory installed. Reference Quick Start QS101 “BlueWave AX-550 V2.0 Power Cord Ferrite Core Installation Instructions” for specific wire routing and installation procedure.

Parts Included

- BlueWave AX-550 V2.0 Controller
- BlueWave AX-550 V2.0 Emitter (RediCure, PrimeCure, or VisiCure, model as selected at time of purchase)
- Power Cord
- EMI Filtering Ferrite Core (Assembly Required)
- BlueWave AX-550 V2.0 LED Flood System User Guide (document not shown)
- Terminal Block (Plugged on the BlueWave AX-550 V2.0 Controller)
- Foot switch
- Safety Eyewear

Figure 2.
System Packaging



Figure 3.
Components of the BlueWave AX-550 V2.0 Curing System



System Installation

System Assembly

The system includes two major parts, the Controller and the Emitter. The two parts are shipped separately. To assemble the two parts together, please follow the instruction below:

1. Locate the 4 Screws to be used to assemble the Emitter to the Controller.
2. Carefully place the Emitter on a clean and flat surface. Align the Controller and the Emitter as shown in Figure 4. Plug the Controller into the Emitter.

NOTE: Be careful to keep the glass at the bottom of the Emitter clean. To avoid leaving fingerprints on the glass, do not touch the glass with bare hands.

3. Install the 4 Screws to secure the Emitter to the Controller. Tighten snugly with appropriate screwdriver, failure to install screws will leave the potential for poor electrical grounding of the system.

NOTE: All four screws **MUST** be installed to ensure proper grounding of the system chassis.



WARNING! The BlueWave AX-550 V2.0 is designed and certified to operate as instructed within this document. Alteration of the system or its component installation may pose a shock hazard.

System Cooling

The system can be used in various scenarios with additional mounting fixtures or Dymax accessories. For example: on a desktop with a Dymax stand, on a chamber, conveyer, etc. This system should only be operated in a location that provides proper cooling. Location requirements are as follows:

- For proper cooling of the unit, upper intake and lower exhaust must not be blocked.
- Minimum clearance as shown in Figure 6.
- Note that the lower exhaust may have one side blocked for installations where two units are side by side. The system will operate safely but run hotter.

Figure 4.
Align Controller and Emitter



Figure 5.
Install 4 Screws



Figure 6.
Minimum Clearance



Wiring and Connections

All the wire and cable connections are at the top side of the controller.

NOTE: For convenience, the I/O Interface contains two chassis ground connections that are in common with the earth connection of the power plug. These are the only two connections that should be used to make external connections to earth ground.

Power Input: The power cord plugs in here. Only use the power cord supplied by Dymax. The power cord supplied with the Controller is specifically designed and certified to work with the Controller. The Dymax supplied power cord contains a special ferrite at the plug end which is required for proper operation of the Controller.



WARNING! The BlueWave AX-550 V2.0 is designed and certified to operate with the Dymax supplied 10Amp, 18AWG, 3 conductor power cord with ferrite core. Do not use any other non-standard power cord that does not have the same current rating and does not have the correct ferrite core installed.

Power Switch: Turns the unit on and off.

I/O Interface: Reference connector pin-out on the back of the controller (Figure 8). Provides for wiring of remote-control features including foot switch, inhibit/interlock, PLC and status signals.

Note: I/O connector type Phoenix Contact, Combicon, 1790360

Figure 7.
Controller, Topside

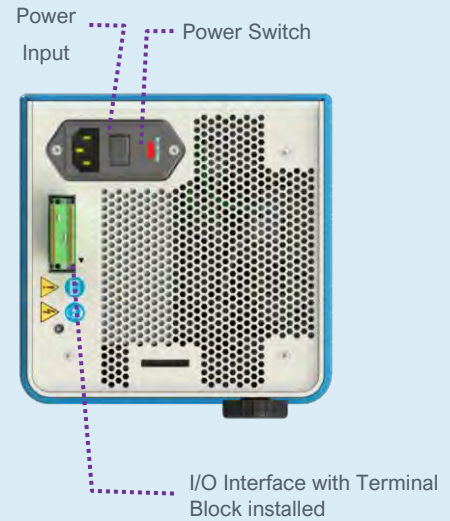



Figure 8.
PLC Connector Pin Reference



FUSE			
 F 10 A 250 VAC ~100-240 VAC 50/60 Hz 10 A			
PLC CONNECTOR			
▲ SPARE	1	9	SPARE
SPARE	2	10	SYSTEM HEALTH
ANALOG INTENSITY	3	11	LED STATE
PLC GND	4	12	PLC ENABLE
MASTER INTERLOCK	5	13	CHASSIS GND
LED ON/OFF	6	14	CHASSIS GND
INTENSITY INT/EXT	7	15	LED INHIBIT
PLC PWR	8	16	COM
COM	A	B	COM

Connections

An 18-pin removable terminal block (the green part in Figures 9-11) comes with the controller. The terminal block allows quick and easy wiring. The terminal block can fit the wire from AWG 24 to AWG 16.

General Instructions for Terminal Attachment

- **To connect a hard wire to the terminal block** (such as the foot switch terminals): Plug the end of the wire into the terminal (Figure 9).
- **To connect a soft wire to the terminal block or pull out the wire from the terminal block**: Use a flat screwdriver to push the orange tab located beside the terminal. Then plug the wire in or pull the wire out (Figure 10).
- **To remove the jumper from the terminal block**: Use two flat screw drivers to simultaneously push the orange tabs located beside the terminal. Then pull the jumper out. (Figure 11)

Figure 9.
Insert Hard Wire into Terminal Block

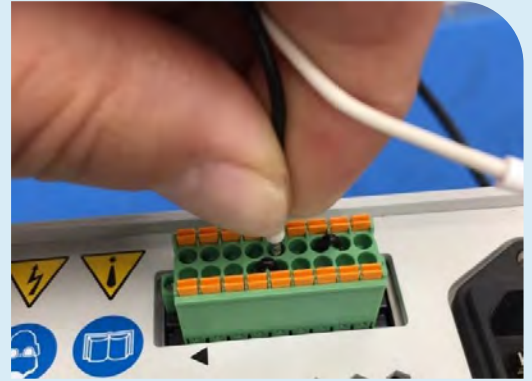

Figure 10.
Insert Soft Wire or Pull Wire Out of Terminal Block

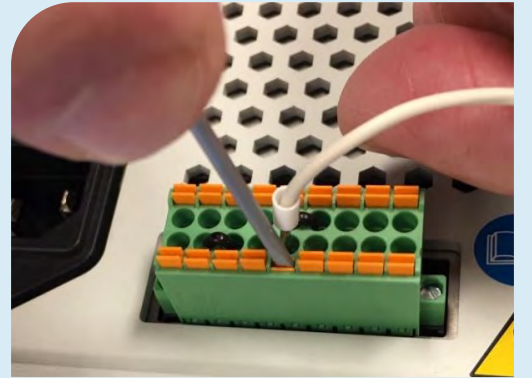

Figure 11.
Remove Jumper from Terminal Block



I/O Interface Summary

Table 1 below shows the summary of all signals on the PLC Connector.

Table 1.
I/O Interface

Signal Name / Description	PIN #	Signal Level	
		Asserted	De-Asserted
INPUTS			
SPARE(S)	1, 2, 9	Do Not Use	
ANALOG INTENSITY Only used in PLC – EXT mode Sets Emitter intensity level (0~1V=10% output, 10V=100% output) Input Impedance: 10KΩ	3	0 – 10 VDC	N/A
MASTER INTERLOCK Input Current: 0 – 7mA	5	0 VDC, GND	(Open)
PLC ENABLE Input Current: 0 – 7mA	12	0 VDC, GND	(Open)
LED ON/OFF Input Current: 0 – 7mA	6	0 VDC, GND	(Open)
INTENSITY INT/EXT (Internal/External control) Input Current: 0 – 7mA	7	0 VDC, GND	(Open)
LED INHIBIT Input Current: 0 – 7mA	15	0 VDC, GND	(Open)
OUTPUTS			
PLC POWER ⁽¹⁾ (24V, 500mA maximum)	8	Always On	
SYSTEM HEALTH Sink Current: 50mA max.	10	0 VDC, GND	Open
LED STATE Sink Current: 50mA max.	11	0 VDC, GND	Open
RETURNS (These pins are common and may be used interchangeably)			
PLC GND (Common signal return)	4	PLC mode Ground	
COM (Common signal returns)	A, B, 16	Common Grounds	
CHASSIS GROUND (These pins are common and may be used interchangeably)			
Chassis Grounds ⁽²⁾	13,14	Chassis Ground	

(1) PLC power channel is a 24V source available for use to drive PLC logic but must be current limited using pull-down resistors to protect the BlueWave AX-550 V2.0 when directly attached to the I/O channels through the PLC connector.

(2) CHASSIS Ground connections do not share a common connection with signal returns and cannot be interchanged with signal returns.

Connect Power Cord

1. The Dymax supplied Power Cord requires installation of a Ferrite at the plug end for proper operation of the Controller (Figure 12). Please refer to [“QS101 - BlueWave AX-550 V2.0 Power Cord Ferrite Core Installation Instructions”](#) for complete installation instructions.

Figure 12.
Power Cord with Ferrite.



2. Once the Ferrite has been attached to the Power Cord, plug the Power Cord into the Power Input located on the unit's top panel (Figure 7).
3. Plug the opposite end of the Power Cord into an appropriate AC outlet. The system uses universal 100 ~ 240 VAC power.

WARNING! *If the BlueWave AX-550 V2.0 controller is powered on without an LED emitter connected, the controller screen will show an alert notification and audible alarm.*

Connect the Inhibit/Interlock PLC Controls

There are 2 control inputs to disable the UV output. These 2 signals must be connected to PLC GND or COM to enable proper operation of the system. The factory supplied I/O connector has jumpers installed for basic operation.

The LED INHIBIT is used to disable the UV output at the emitter head when the jumper or circuit attached is open.

- LED INHIBIT is controlled by connecting Pins 15 and 16 on the PLC terminal block.

The MASTER INTERLOCK is used to disable the UV output at the controller when the jumper or circuit attached is open.

- MASTER INTERLOCK is controlled by connecting Pins 4 and 5.

See Figure 13 for the jumper and Figure 15 for the example connection.

Figure 13.
Factory Jumpers on the PLC Connector, Viewed from Backside

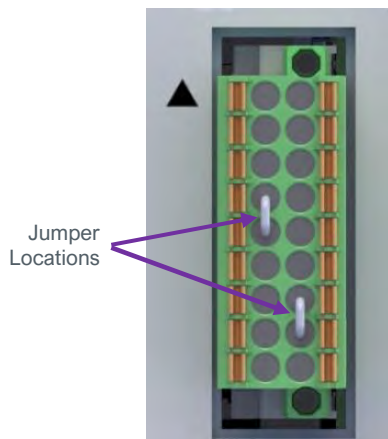

Figure 14.
PLC Connector Pin Map with Jumper locations highlighted

FUSE			
 F 10 A 250 VAC ~100-240 VAC 50/60 Hz 10 A			
PLC CONNECTOR			
▲ SPARE	1	9	SPARE
SPARE	2	10	SYSTEM HEALTH
ANALOG INTENSITY	3	11	LED STATE
PLC GND	4	12	PLC ENABLE
MASTER INTERLOCK	5	13	CHASSIS GND
LED ON/OFF	6	14	CHASSIS GND
INTENSITY INT/EXT	7	15	LED INHIBIT
PLC PWR	8	16	COM
COM	A	B	COM

Figure 15.
Example Connection for LED INHIBIT and MASTER INTERLOCK



Connect Foot Switch

To control UV illumination with the foot switch option, connect as shown below.

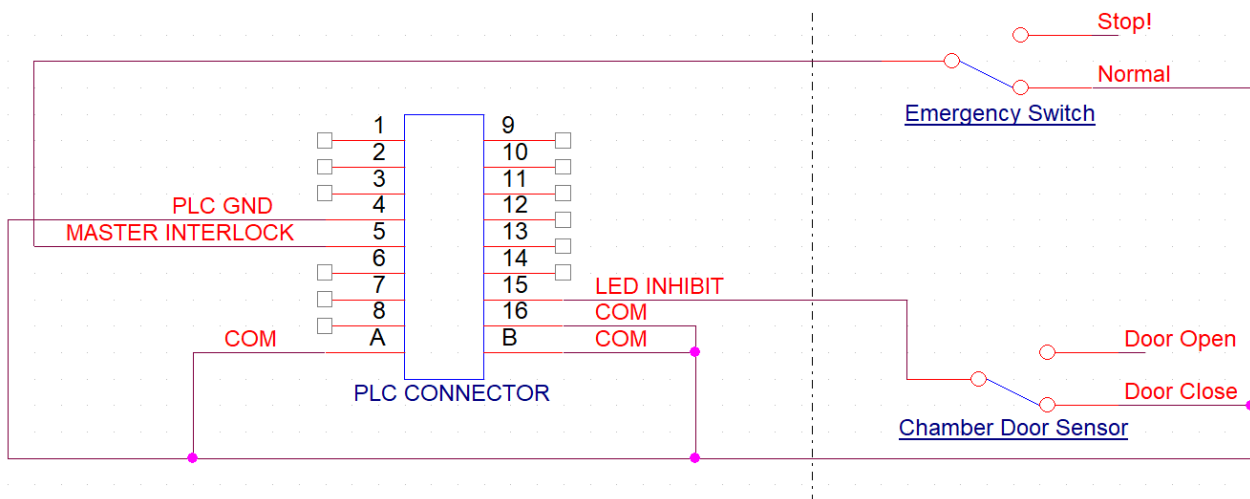
- Red Wire to LED ON/OFF PIN 6
- Black Wire to a COM PIN (A)
- Green/Yellow Wire to CHASSIS GND PIN 14

Figure 16.
Foot Switch

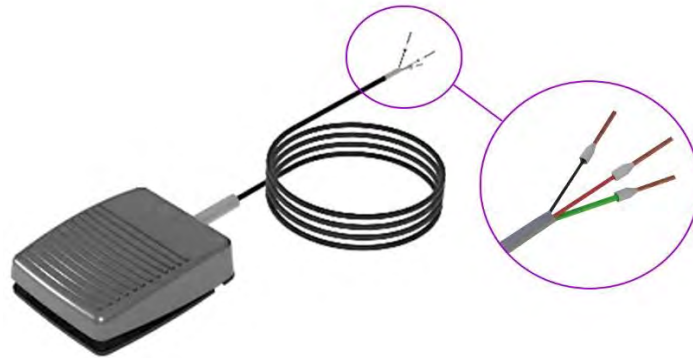
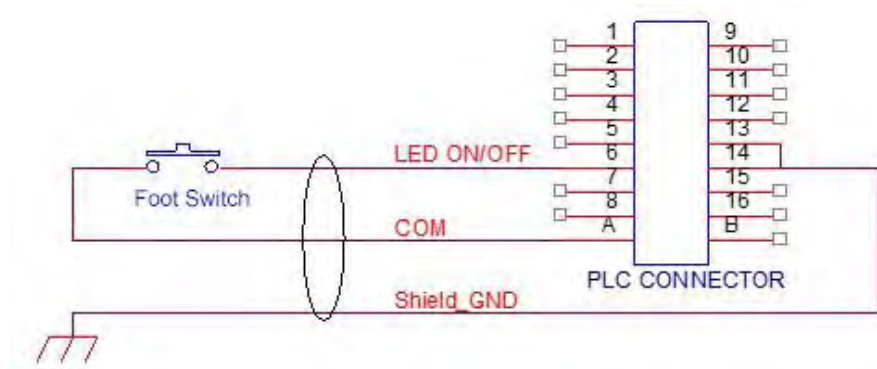

Figure 17.
Foot Switch Wiring Pin Locations



FUSE			
F 10 A 250 VAC			
~100-240 VAC 50/60 Hz 10 A			
PLC CONNECTOR			
▲ SPARE	1	9	SPARE
SPARE	2	10	SYSTEM HEALTH
ANALOG INTENSITY	3	11	LED STATE
PLC GND	4	12	PLC ENABLE
MASTER INTERLOCK	5	13	CHASSIS GND
LED ON/OFF	6	14	CHASSIS GND
INTENSITY INT/EXT	7	15	LED INHIBIT
PLC PWR	8	16	COM
COM	A	B	COM

Figure 18.
Foot Switch Schematic



PLC UV Control

PLC switching may be driven by manual switch, relay, or optical coupler. Only analog intensity uses a voltage input to the PLC.

To use the PLC mode inputs, the **PLC ENABLE** pin 12 must be pulled down to low by grounding to the PLC return, **PLC GND** or a **COM** ground point

The PLC can control the UV on/off using the **LED ON/OFF** input Pin 6. When this input is pulled down by grounding to **COM** ground, the UV LED will turn on.

The PLC can also control the intensity of the UV output.

- When the **INTENSITY IN/EXT** input Pin 7 is pulled down low by grounding to **COM** ground, the Intensity will be controlled by the **EXTERNAL ANALOG INTENSITY** input voltage.
- The **ANALOG INTENSITY** input, Pin 3, is an analog voltage input. The voltage range is 0 to 10VDC.

Any setting 1 VDC or below will set the Intensity to 10% and each additional volt increases intensity by 10%. (Example: 5V = 50%, 7.5V = 75%, 10V = 100%) All three PLC inputs, **LED ON/OFF**, **INTENSITY IN/EXT** and **ANALOG INTENSITY** work in PLC mode only. They are ignored in other working modes. The example connection for the PLC control signal is shown in Figure 19.

Figure 19.
PLC Connection

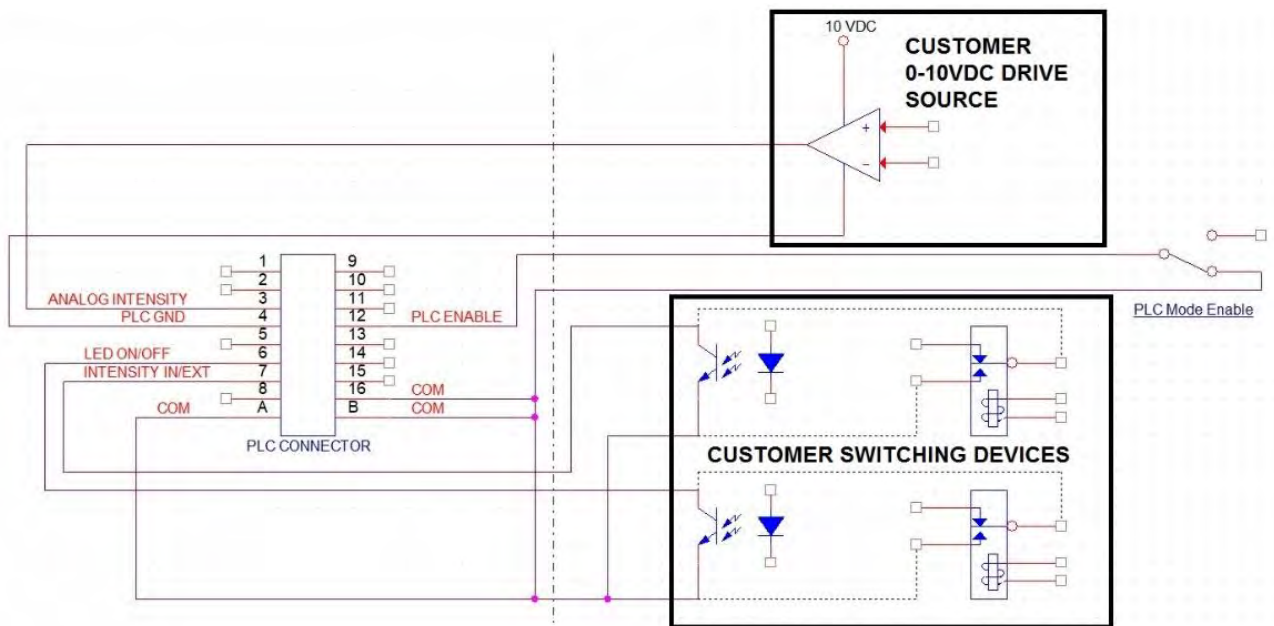

Status Output

There are two status outputs. They are driven by an optical coupler. These outputs work in any mode, and can be used as status inputs for PLC or any status display/monitor purpose.

- **System Health** - Output low to indicate the unit is normally working.
- **LED State** - Output low to indicate the UV LEDs are ON.

The example application of these signals is shown below in Figure 20.

Figure 20.
Status Outputs Connection Using On-Board 24V Source

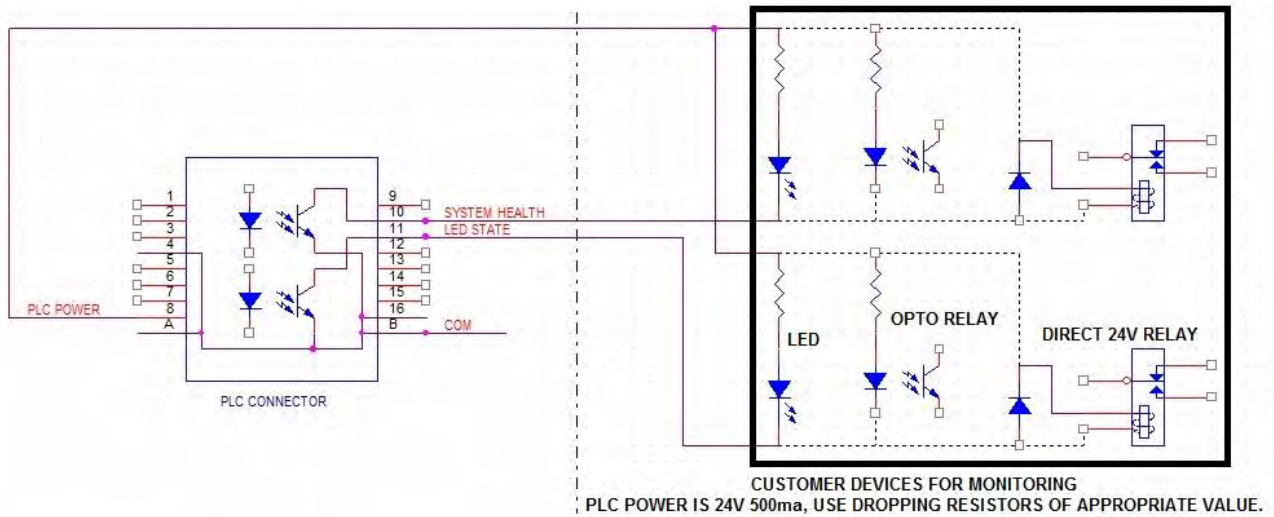

PLC Power channel is a 24V source available for use to drive PLC logic but must be current limited using pull-down resistors to protect the BlueWave AX-550 V2.0 when directly attached to the I/O channels through the PLC connector.

Figure 21.
PLC Status Outputs Using Customer-Supplied 24V Source

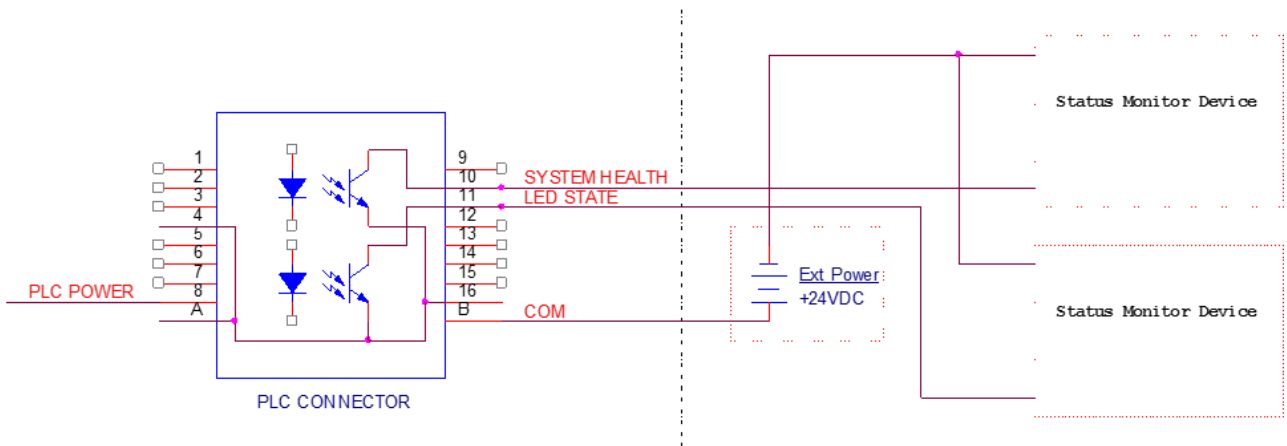

For sinking current below 7mA it is suggested when using solid state relays to use one of these devices:
Weidmuller 8820710000, Phoenix Contact 2980636.

Figure 22.
Examples of Customer Configurations for Monitoring Outputs

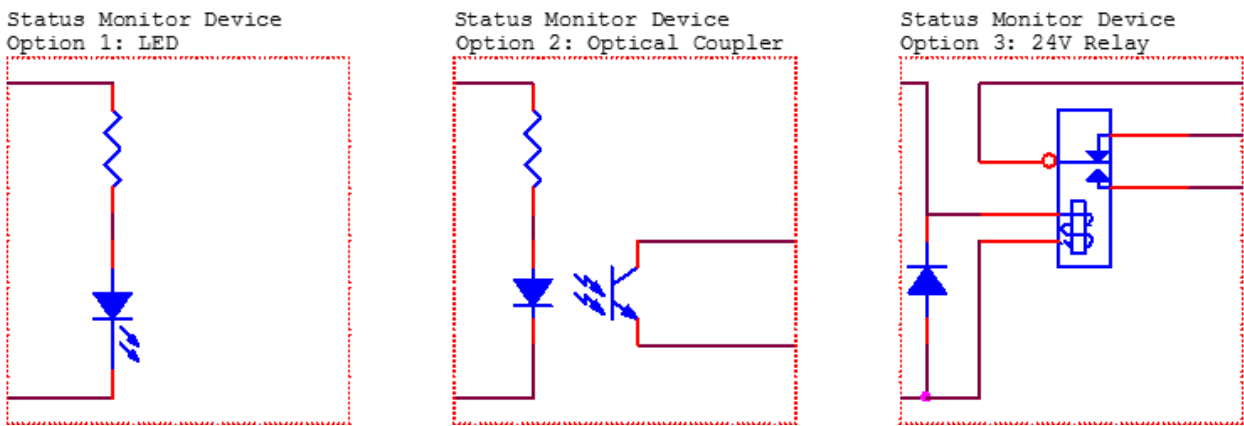

PLC Power channel is a 24V source available for use to drive PLC logic but must be current limited using pull-down resistors to protect the BlueWave AX-550 V2.0 when directly attached to the I/O channels through the PLC connector.

Operation

To operate the BlueWave AX-550 V2.0 system:

1. Verify that the Controller and Emitter are assembled properly, the input power is correctly plugged into the AC Inlet on the top of the unit, and the Interlock Jumpers (or external safety sensor) are installed between Pins 4 & 5, and 15 & 16 of the I/O Connector on the top of the unit.
2. When all connections are properly made, toggle the Power Switch on the top of the unit. The system is now ready for use.

System Initialization

Upon startup of the unit, a splash screen displays the controller and emitter FW versions. After about 6 seconds, the control screen should appear in the display. The unit loads in administrator mode the first time it's started.

The control screen is used to set up and run curing cycles. Admin screen allows users to switch back and forth between admin/production mode if the PLC mode is disabled. Curing parameters are set in the admin screen.

Rotary Pushbutton

The front panel on the controller features a rotary pushbutton which can be used for function selection and for modifying all adjustable irradiation parameters when not in PLC mode. Specific irradiation settings may also be saved and loaded using the Program Load/Save feature explained in a later section. All settings and status can be viewed on a color LCD display.

- Turning the rotary pushbutton moves the selection field as indicated on the LCD display.
- Pressing the center of the rotary pushbutton selects the menu item or sets the input for the active field.

NOTE: The selected value will appear in blue color, when selected value requires modification press the rotary pushbutton, then, this value will turn yellow indicating it is ready to be modified. Turning the rotary pushbutton changes the value to be selected.

Figure 23.
Front Panel

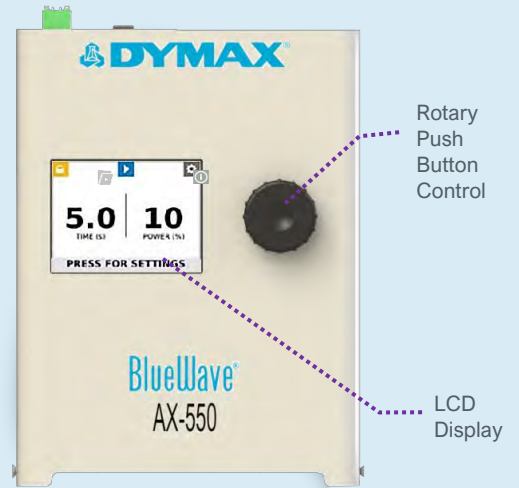

Figure 24.
Initializing Screen



Figure 25.
Set and Modify a new value.



System Initializing

The system is designed to work in any one of three modes of operation as indicated in the upper left of the display:



Admin Mode: The administration mode allows full control of system functions.



Production Mode: This mode doesn't allow changes to the irradiation parameters.



PLC Mode: in PLC mode, an external PLC can control the unit.*

**NOTE: PLC Mode icon is located in the upper right of the display.*

To enter PLC mode, connect the external PLC system and toggle the **PLC ENABLE (Pin 12)** input Low to 0VDC. The PLC icon will be seen on the screen automatically. Leave the PLC ENABLE open to enter the Administrator or Production mode.

Selecting the padlock button switches between Administration and Production modes, a password will be required to enter admin mode.

The default password to enter admin mode is **00000**. To change the password, please see "System Settings" and Figure 32.

NOTE: Switching between PLC and non-PLC mode can happen when the system is powered ON or OFF, but the LED must be OFF for safety.

Information



Information: Displays system information.

Only available in Admin mode, using the rotary pushbutton select the information icon in the upper right area of the LCD screen.

Push the rotary pushbutton and the "Information" screen will appear.

The following Controller/Emitter system information will be displayed.

1. The Controller Serial Number and Firmware Revision.
2. The Emitter Array Type (RediCure, PrimeCure, VisiCure).
3. The Emitter Array Serial Number and Version.
4. The Calibration Date (yy/mm): target intensity.
5. The maximum (temperature, current draw, voltage level), experienced by the Emitter Array.
6. LED HRS (Total time the emitter array has been illuminated).
7. LED PRH (Power Rated Hours = Total time the emitter array has been illuminated* Power Setting / 100).

Push the rotary pushbutton to return to the main screen.

Figure 26.
Padlock location

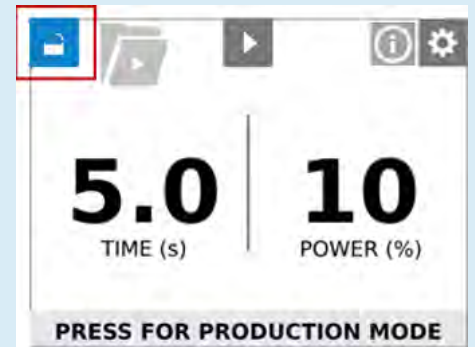
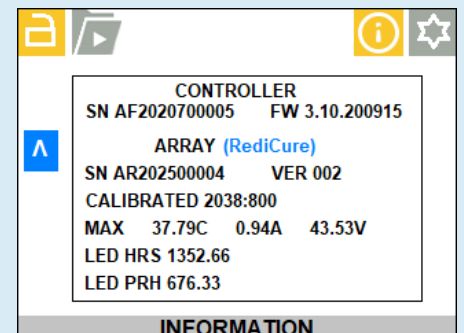

Figure 27.
Information screen



System Settings

In Admin Mode or Production Mode, select the settings icon located at the upper right corner.



Settings: Loads the settings screen where the volume, language, screen brightness, and other user settings can be adjusted.

In admin mode, the settings screen shows all settings (Figure 28). In the production mode, the settings screen layout is identical to the admin screen, except the admin settings option is not available (Figure 29).

Settings Screen



Language - Future support for multiple languages.



Brightness - Opens the brightness screen where the adjustment of the LCD backlight can be modified in a range from 1 to 10.



Volume - Opens the volume screen where the operation volume can be modified in a range from 0 to 10.



Admin - While in Admin mode opens the user screen where boot mode can be selected and the Admin password may be accessed.

The settings and operations for both Admin and Production Mode are shown below:

Figure 28.
Admin Mode Settings Screen

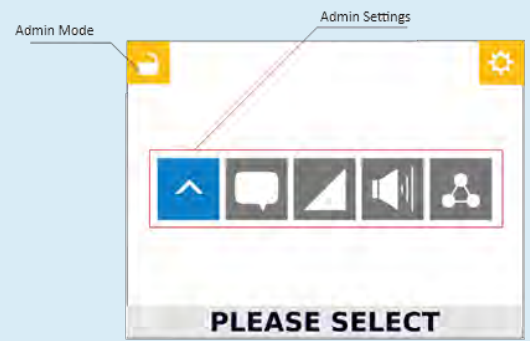

Figure 29.
Production Mode Setting Screen

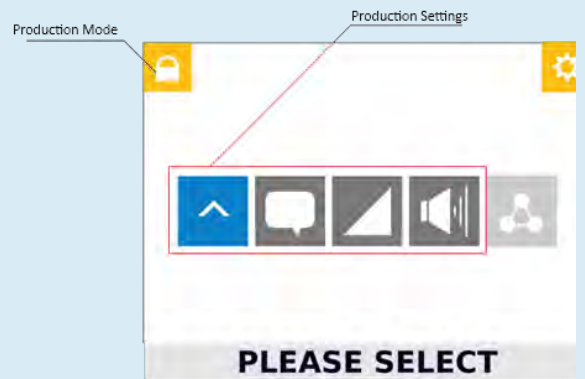

Figure 30.
Configuration Settings

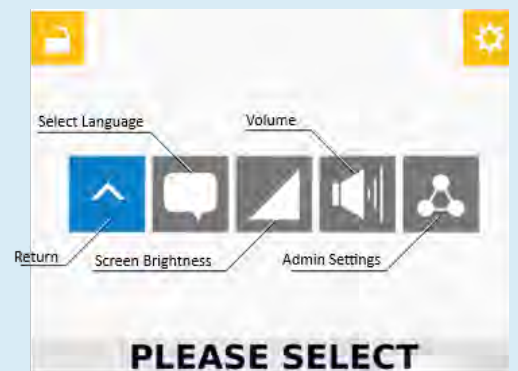







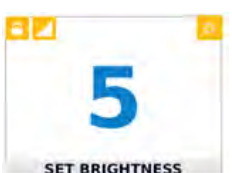



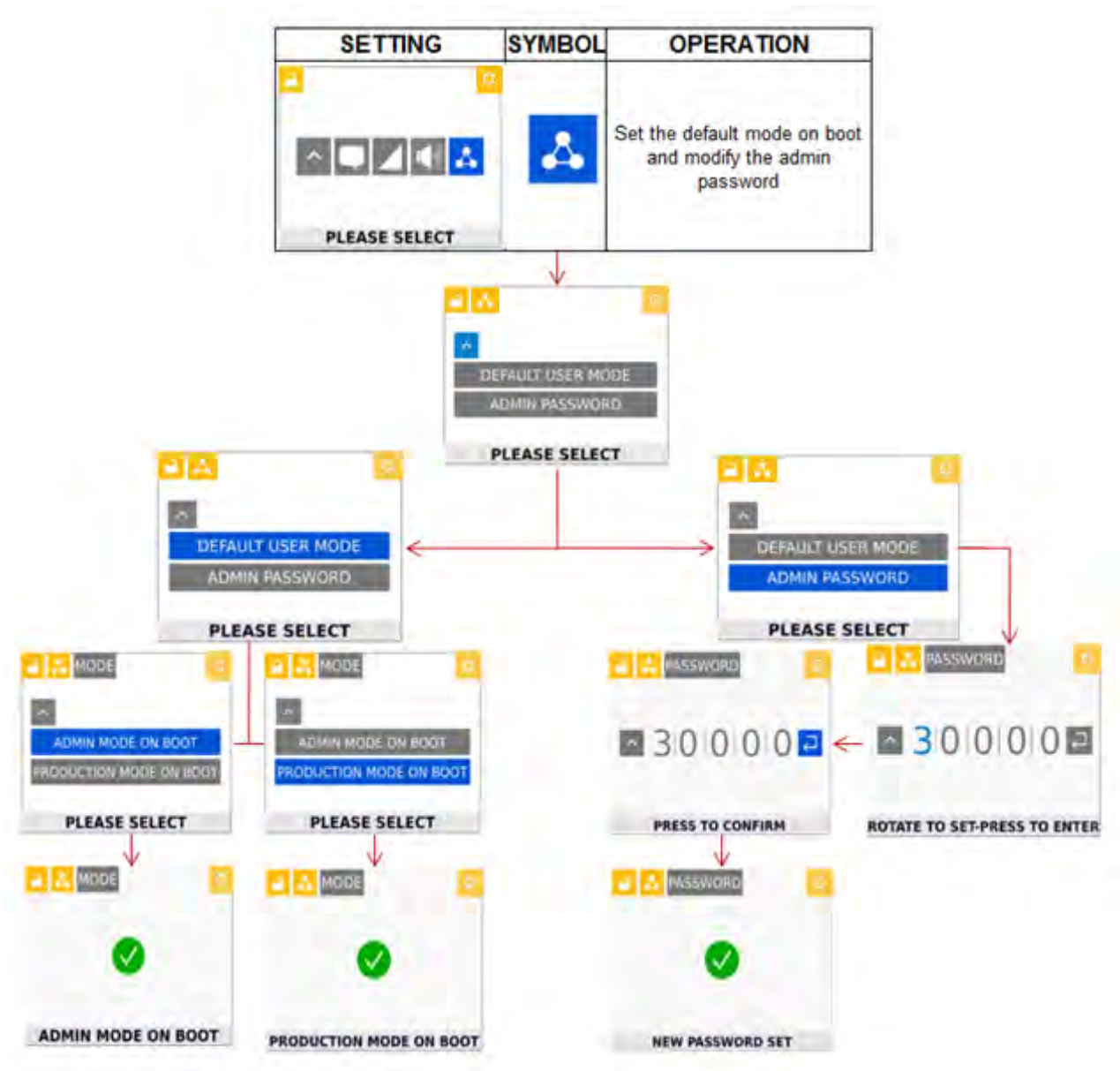

Table 2.
Production and Admin Settings Menu

Setting	Symbol	Operation	Operation Result
		Press the rotary pushbutton when it turns blue to return to the previous menu or to ignore the changes made and keep the current value	
		Used to change the language (only English is available at this time)	
		Opens the brightness screen where the adjustment of the LCD backlight can be modified in a range from 1 to 10, 1 to get the lowest luminosity and 10 the highest luminosity	
		Used to change the operation volume in a range from 0 to 10, 0 to get the mute mode and 10 the highest volume	

The settings and operations for Admin Mode only are shown below:

Figure 31.
Admin Only Settings



Default User Mode Screen

ADMIN ON BOOT - Controller enters Admin mode immediately after power-up.

PRODUCTION ON BOOT - Controller enters production mode immediately after power-up.

Admin Password Screen

Set up the admin password as instructed below.

The password is typed and confirmed in the password screen via the rotary pushbutton. The Password fields only accept a numeric password from 0 to 9 in each column, the password must have 5 characters. Follow the steps shown below to entry a new password.

Note: For lost passwords contact Dymax Customer Support for Engineering Access

Figure 32.
New Password Screens

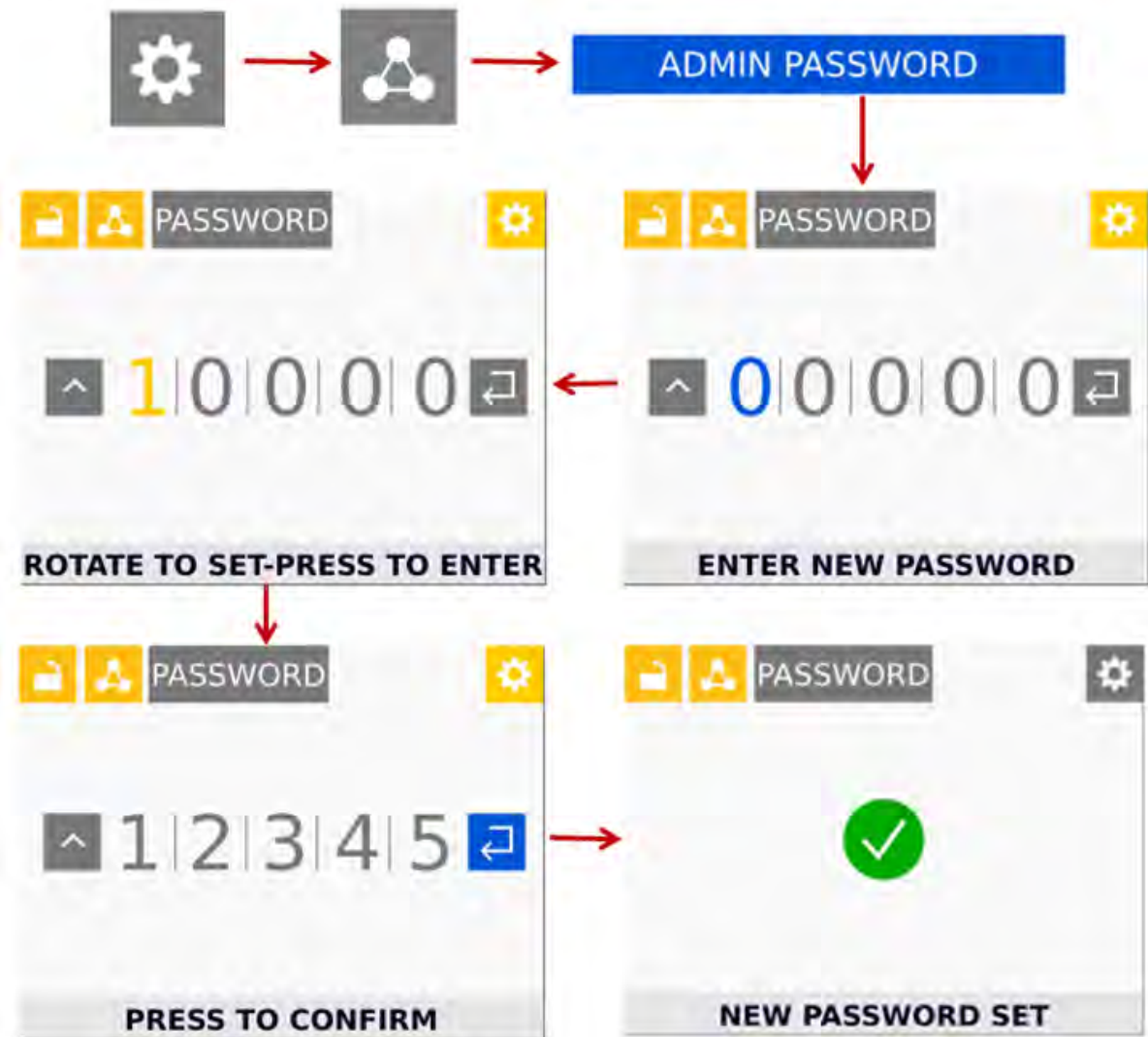

Swap Between Admin and Production Mode

To change from admin mode to production mode: Select the padlock icon at the upper left corner of the screen (which is un-locked) using the rotary pushbutton. Push the center of the rotary pushbutton. The padlock icon will become locked. This indicates that the mode has switched to production mode.

To change from production mode to admin mode: Select the padlock icon at the upper left corner of the screen (which is locked) using the rotary pushbutton. Push the center of the pushbutton. The “Enter Password Screen” will appear.

Enter the admin password which was set up in Figure 32, or the default password, **00000**. Confirm the password to enter the admin mode. See Figure 35.

Figure 33.
Padlock Icon for Admin and Production Mode



Figure 34.
Enter Password Screen



Figure 35.
Confirm Password Screen

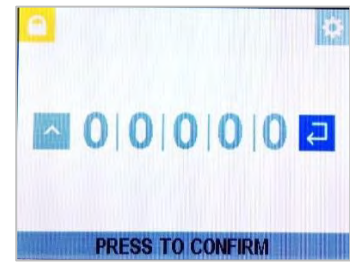

Program Load/Save



Program: Loads/Saves the current time and power settings.

Only available in Admin mode, using the rotary pushbutton select the program icon located in the upper left area of the display as shown. Push the rotary pushbutton and the “Load/Save Program” screen will appear.

Use the rotary pushbutton to highlight the desired program, push the rotary pushbutton to select the desired program, see Figure 36. Use the rotary pushbutton to select Save or Load; to save the current Settings to the selected program or load the selected program settings into the unit, see Figures 37 & 38.

Figure 36.
Load/Save Program

Program	Timer	Power	
1	30.7	100	SAVE LOAD
2	900.0	50	SAVE LOAD
3	1.5	75	SAVE LOAD
4	0.8	95	SAVE LOAD
5	120.0	33	SAVE LOAD
6	60.0	66	SAVE LOAD
7	0.0	10	SAVE LOAD
8	0.0	10	SAVE LOAD

PRESS TO SAVE / LOAD

Figure 37.
Load Program Screen

Program	Timer	Power	
1	30.7	100	SAVE LOAD
2	900.0	50	SAVE LOAD
3	1.5	75	SAVE LOAD
4	0.8	95	SAVE LOAD
5	120.0	33	SAVE LOAD
6	60.0	66	SAVE LOAD
7	0.0	10	SAVE LOAD
8	0.0	10	SAVE LOAD

PRESS TO LOAD

Figure 38.
Save Program Screen









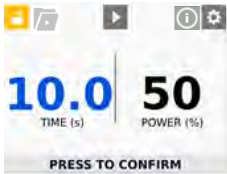

Program	Timer	Power	
1	30.7	100	SAVE LOAD
2	900.0	50	SAVE LOAD
3	1.5	75	SAVE LOAD
4	0.8	95	SAVE LOAD
5	120.0	33	SAVE LOAD
6	60.0	66	SAVE LOAD
7	0.0	10	SAVE LOAD
8	0.0	10	SAVE LOAD

PRESS TO SAVE

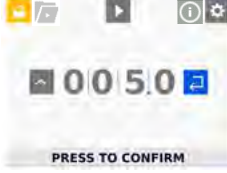
Irradiation Setup

To start a new irradiation, it is necessary to confirm TIME and POWER values. These values can be changed in admin mode only. To modify the values, follow the steps shown below.

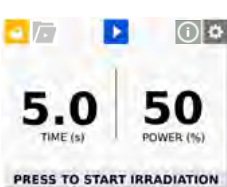
Table 3.
Irradiation Setup

Time Setting	Power Setting	Operation
		To choose between the TIME or POWER settings, turn the dial to the desired setting, it will turn blue, then press the dial, the time and power level screen will be accessed.
		<p>TIME: The irradiation time is shown in the first column on the heading "Time (s)". The input range is from 0.1 to 999.9 seconds with a resolution of 0.1(s), set the number one by one until get the desired time.</p> <p>POWER: The cure power intensity is displayed as a percentage in the second column, above the heading "Power (%)". Power may be set from 10 to 100%, the adjustment can be made in increments of 1%.</p> <p>NOTE: The timer value of 999.9 is displayed as 999.</p>
		When the desired value has been selected, place the rotary pushbutton on the enter symbol  , then press the rotary pushbutton to set the new TIME or POWER values and return to the previous menu.
		A success screen will appear when the established data are valid.
		The setup is complete and the unit is ready to start a new irradiation by pressing the rotary pushbutton. 

Curing Time Screen

By pressing the time display/button you can access the timer setting. You must turn rotary pushbutton to select the desired time and press it to accept the set value (Figure 39). The entry range is from 0.1 to 999.9 seconds with a resolution of 0.1(s).

Figure 39.
Curing Time Display



Power Level Screen

By pressing the power display/button you can access the power setting. You must turn rotary pushbutton to select the desired power and press it to accept the set value (Figure 40). The power level range is 10% to 100% in increments of 1%.

Figure 40.
Power Level Screen



Note: the minimum power value to configure LED intensity must be 10% to avoid linearity in irradiation area intensity. If the set value is less than 10, it will be taken as an invalid setting and it will be necessary to enter a new value.

Figure 41.
Invalid Setting Screen

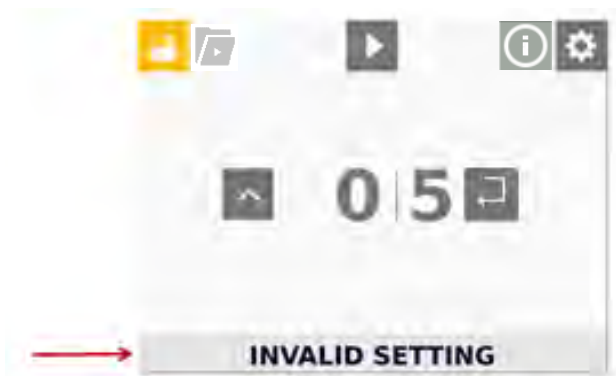

Irradiation in Production or Admin Mode

To run the exposure cure cycle in Production or Admin mode, a timer and power setting is required.

Timer

The timer can be setup in Admin mode only. The range of the timer is 0 to 999.9 seconds.

If the timer is set to 0, the UV LED will be controlled by the pushbutton and/or the foot switch (if connected to LED ON/OFF, COM input). When the pushbutton or the foot switch is pushed down, the UV will turn on; when both the pushbutton or foot switch are released, the UV will turn off.

If the timer is set to non-zero value, the rotary pushbutton or the foot switch will start the UV LED, and the timer will count down.

When the timer counts down to zero, the UV LED will turn off. The timer is reset to the pre-set value, and the system is ready to run another exposure cycle.

A timed cycle may be interrupted before the timer counts down to zero. You may re-assert the trigger by rotary pushbutton or foot switch during the cycle and it will turn off the UV LED immediately and reset the timer to the pre-set value, and the system is ready to run another exposure cycle.

Power

The UV power level can be set in the Admin Mode. The range is from 10% to 100% of the full power.

Figure 42 shows the operation interface in Timer Mode. To select RUN, turn the rotary pushbutton to move the highlight over the RUN icon, then push the center of the rotary pushbutton. This will run and stop the LEDs' irradiation.

If the foot switch is connected, pressing the foot switch can highlight the RUN icon immediately, no matter which icon was highlighted before.

If the timer is set to 0, pressing the foot switch will turn on the UV LED; releasing the foot switch will turn off the UV LED.

Figure 42.
Timer Mode Interface



Irradiation in PLC mode

When in PLC mode, an external PLC can control the unit. The PLC provides input signals to the BlueWave AX-550 V2.0 LED Flood System to control the on/off signals and intensity of the LEDs. The PLC can also monitor the status of the system by reading output signals provided by the unit.

Figure 43.
PLC Mode Screen States



PLC Screen Detailed Description:

1. **LED ON/OFF Input:** The status of UV LED control input (PIN 6 in). The screen shows **TRUE (1a)** when the input is connected to common to turn on the UV LED; and shows **FALSE (1b)** when the input is open and the UV LED should be off. The minimum signal pulse width High or Low is 500ms.
2. **LED Inhibit:** The input status of **LED INHIBIT (PIN 15 in)**. Enables or prevents the UV irradiation, to allow irradiation, the screen must display a FALSE state (**2a, 2b**). When irradiation is disabled a **TRUE** state will be seen. LED inhibit is typically wired to the door of a **Light Shield** unit. When LED Inhibit line is not connected to common, an error warning of **LED INHIBIT OPEN** will be seen.
3. **LED Activated:** Displays the UV LEDs irradiation status as ON (**3.a TRUE**) or OFF (**3.b FALSE**).
4. **LED Intensity (%):** Indicates the light intensity percentage value (**4a, 4b**) for the next time when the UV LEDs will operate, The value can be set by either **ANALOG INTENSITY** input (PIN3 in) in PLC mode or the control panel in Admin mode.
5. **LED Intensity Control:** The status of **INTENSITY** source (PIN7 in). Displays whether the LED light Intensity is controlled via PLC's **ANALOG INTENSITY** pin. **PLC (5.a)** or whether the last power value set on the control panel **PANEL**.

If the Intensity is set by the ANALOG INTENSITY input, the intensity value will be locked when the LED is activated. The LED Intensity setting can change according the ANALOG INTENSITY input but will take affect only at the time that the LED become Activated.

6. **Master Interlock:** The input status of the **MASTER INTERLOCK (PIN5 in)** is shown as **FALSE (6a, 6b)** if the pin connected to common and shown as **TRUE** if the pin is open. The **TRUE** input will disable the UV operation, and an error warning **MASTER INTERLOCK OPEN** will be shown on the bottom of the screen. For normal operation, the status should be FALSE, ie, the pin should be connected to common.

To run a curing cycle in PLC mode:

1. Assert the PLC ENABLE input (connect the input to COM), PLC screen should appear.
2. Set the intensity level source by toggling the LED INTENSITY INT/EXT line. INTERNAL mode uses the value set in the controller. EXTERNAL source requires a voltage input based on a 1 volt DC = 10% power up to 10 volts DC for 100%.
3. Assert both MASTER INTERLOCK and LED INHIBIT (connected both to COM), then assert the LED ON/OFF line, the system starts the irradiation, irradiation will end when de-asserting the LED ON/OFF.

Figure 44.
PLC Screen, UV LED Inactivated (Off)

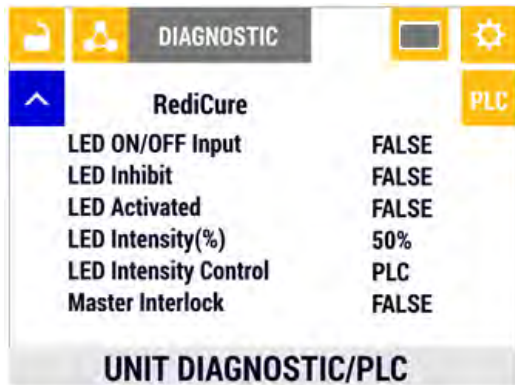

Figure 45.
PLC Screen, UV LED Activated (On)



Maintenance

Product Cleaning

Product cleaning is limited to wiping the product with a damp cloth. Do not soak. Isopropyl Alcohol and mild detergent may be used for cleaning the product.

Emitter Replacement

To replace the emitter, follow these steps:

1. Place the unit on a flat surface and remove the 4 M3 Screws located on the sides using a 2.0-mm Hex Screwdriver. (Figure 46)
2. Remove the Emitter section carefully and replace it with the desired Emitter. (Figure 47)
3. Reinstall the 4 M3 Screws Removed in Step 1 (Figure 48). The unit is now ready to be used.

Figure 46.
Remove M3 Screws



Figure 47.
Remove Emitter Section



Figure 48.
Replace Emitter and Reinstall Screws



Replace Fuse

To replace the fuse, follow these steps:

1. Open the Fuse Cover using flat screwdriver. (Figure 49)
2. Lift the Fuse Holder using the flat screwdriver. (Figure 50)

Figure 49.
Open Fuse Cover



Figure 50.
Lift Fuse Holder



3. Take out the Fuse Holder. (Figure 51). *Note that the fuse holder is labeled for correct orientation.*
4. Replace the fuses with Littelfuse 312 series 250V 10 amp fast acting fuses and put the fuse holder back into the power entry module. (Figure 52)

Figure 51.
Remove Fuse Holder

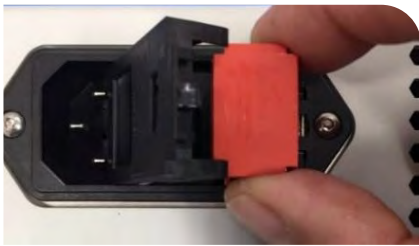

Figure 52.
Replace Fuse



5. Verify the installation is correct by noting the word "FUSED" in the window of the fuse mount.

Figure 53.
Fuse Mount Window



Troubleshooting

WARNING! Only qualified maintenance personnel should attempt the following procedures:

Table 4.
Troubleshooting Chart for BlueWave AX-550 V2.0 Flood Curing System

Problem	Possible Cause	Corrective Action
BlueWave AX-550 V2.0 system does not power up	Power cord not plugged in or damaged.	Check power connection and condition at power source and AC Inlet fuse of the unit.
	No electrical power at Receptacle.	Test Receptacle for power.
BlueWave AX-550 V2.0 system powers up but the emitter does not emit light	MASTER INTERLOCK and/or LED INHIBIT is open.	Verify both of MASTER INTERLOCK and LED INHIBIT are connected to common directly or through the safety sensor. Verify PLC command structure for PLC mode.
	Emitter is not connected to the Controller.	Verify that the Emitter is connected to the Controller.
BlueWave AX-550 V2.0 system is operating normally and the emitter suddenly stops emitting light	Over-temperature shutdown was triggered.	Verify error information.
	MASTER INTERLOCK or LED INHIBIT is open.	Verify interlock jumpers are in place. Verify PLC command structure for PLC mode.
LED emitter provides only low-intensity light	LED intensity set too low.	Increase LED intensity setting on Admin Settings or I/O input for PLC Mode.
	Contaminated/dirty lens optics.	Clean the surface of the Lens.
Foot switch does not function correctly	Foot switch not connected or connected to wrong I/O connector pins.	Verify connections to Pins 6 & COM of the I/O connector.
	Foot switch defective.	Activate unit using the front panel rotary pushbutton. Replace the foot switch if the unit operates from the rotary pushbutton.

Error Screen

If the unit is powered up, and some error happens, the error screen will appear.

The error screen will display the system serial number, controller and driver firmware versions, a technical support phone number for more information, and the current error description.

Figure 54.
Error Screen

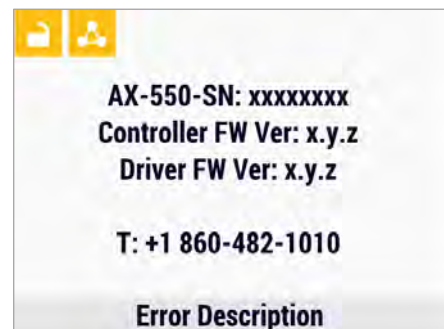

Table 4.
Error Descriptions & Possible Causes

Original Error Description	Possible Cause
Input 24V Low Voltage	Failure on 24V PSU or PSU cabling
Controller Temperature High	Controller temperature found higher than 80 degrees
Controller Fan Not Running	Fan wire maybe disconnected or fan motor malfunctions
Operation Mode Changed	Operation mode change requires a unit reset.
I2C Comm Error	Possible EEPROM chip error
PLC Mode Changed	Mode changed due to switching when power is turned on
PLC LED Inhibit (Chamber Door) open	Chamber door not closed (LED Inhibit PLC line not asserted)
PLC Power Short	Voltage on PLC Power Signal is less than 20VDC, or cable not firmly connected
Driver 0/1/2/3 24V Low Voltage	24V power supply of Driver 0/1/2/3 bad
Driver 0/1/2/3 Temperature 90	Fan not working properly, or air intake blocked
Driver 0/1/2/3 Temperature 80	Fan not working properly, or air intake blocked
Driver 0/1/2/3 Fault Out	LED error found and notified by Driver 0/1/2/3
Driver 0/1/2/3 Comm Bad	Bad communication due to error signal
Driver 0/1/2/3 Channel 0/1 LED Temperature 90	Fan not working properly, or air intake blocked
Driver 0/1/2/3 Channel 0/1 LED Temperature 80	Fan not working properly, or air intake blocked
Driver 0/1/2/3 Channel 0/1 LED Temperature 70	Fan not working properly, or air intake blocked
Driver 0/1/2/3 Channel 0/1 LED Temperature 0	ADC chip malfunction
Driver 0/1/2/3 Channel 0/1 LED Temperature Low	LED working temperature of Ch0/1 of Driver 0/1/2/3 found lower than low limit
Driver 0/1/2/3 Channel 0/1 LED Temperature High	LED working temperature of Ch0/1 of Driver 0/1/2/3 found higher than high limit
Driver 0/1/2/3 Channel 0/1 LED Voltage Low	LED working voltage of Ch0/1 of Driver 0/1/2/3 found higher than high limit
Driver 0/1/2/3 Channel 0/1 LED Voltage High	LED working voltage of Ch0/1 of Driver 0/1/2/3 found lower than low limit
Driver 0/1/2/3 Channel 0/1 LED Current Low	LED working current of Ch0/1 of Driver 0/1/2/3 found higher than high limit
Driver 0/1/2/3 Channel 0/1 LED Current High	LED working current of Ch0/1 of Driver 0/1/2/3 found lower than low limit
Driver 0/1/2/3 Channel 0/1 LED Out	LED of Ch0/1 of Driver 0/1/2/3 found bad
Driver 0/1/2/3 Channel 0/1 LED NA	LED of Ch0/1 of Driver 0/1/2/3 not found
Driver 0/1/2/3 UART Bad	UART of driver 0/1/2/3 found bad
Driver 0/1/2/3 Incompatible	Driver 0/1/2/3 firmware version not compatible with controller
Nvram Array None	No U-shaped board found or no NVRAM chip found
Nvram Array Bad	The data structure maybe bad
Nvram Driver 0/1/2/3 Bad	NVRAM of driver 0/1/2/3 found bad
Nvram Pc Uart Tx Bad	Possible communication error from computer
Nvram Data NA	No data found in the NVRAM
Nvram Operation Both Bad	No programming or chip error

Spare Parts & Accessories

Accessories

Item	Part Number
Personal Protection Equipment	
Protective Goggles — Green	35286
Protective Goggles — Gray (standard model included with unit)	35285
Face Shield	35186
Radiometer	
ACCU-CAL™ 50-LED Radiometer	40505
Stands	
Mounting Stand	43410
Three-Sided Acrylic Shield	41395

Components & Spare Parts

Item	Part Number
BlueWave AX-550 V2.0 System Controller	60943
BlueWave AX-550 V2.0 Emitter, VisiCure (405 nm)	60754
BlueWave AX-550 V2.0 Emitter, PrimeCure (385 nm)	60752
BlueWave AX-550 V2.0 Emitter, RediCure (365 nm)	60753
Power Cord, North America*	35255
Power Cord, Right Angle, North America*	43435
Power Cord, Type G*	40542
Power Cord, Right Angle, Asia	43450
Power Cord, Right Angle, EU*	43449
Foot Switch	60916
Ferrite Core, Snap-On (Required)	61050
Glass Replacement Kit	60966

* Ferrite core also required (PN 61050)

Specifications



Property	Specification		
Emitter	RediCure	PrimeCure	VisiCure
Output Wavelength	365 nm	385 nm	405 nm
Irradiance Output at 25-mm Working Distance*	650 mW/cm ²	775 mW/cm ²	800 mW/cm ²
Curing Area	5" x 5" [125 mm x 125 mm]		
Power Requirements	100-240 V \approx 10 Amps, 50-60 Hz		
Cooling	Air cooled		
Dimensions (W x D x H)	6.54" x 6.75" x 11.41" [166 mm x 202 mm x 290 mm]		
Weight	14.1 lbs. [6.4 kg]		
Unit Warranty	1 year from purchase date		
Operating Environment	10°C to 40°C (50°F to 104°F) 0 - 80% relative humidity, non-condensing (recommended: 30% RH) 2,000-meter max. altitude		
Shipping and Storage Conditions	Temperature: -20°C to +50°C Humidity: 10 - 80% RH, non-condensing Ship via standard ground, ocean, or air freight		
Certifications	RoHS, CE Marked		

* Irradiance measures are averaged over the calibrated 5x5 exposure area.

Figure 55.
Dimensions



Figure 56.
Mounting Hole Locations and Size

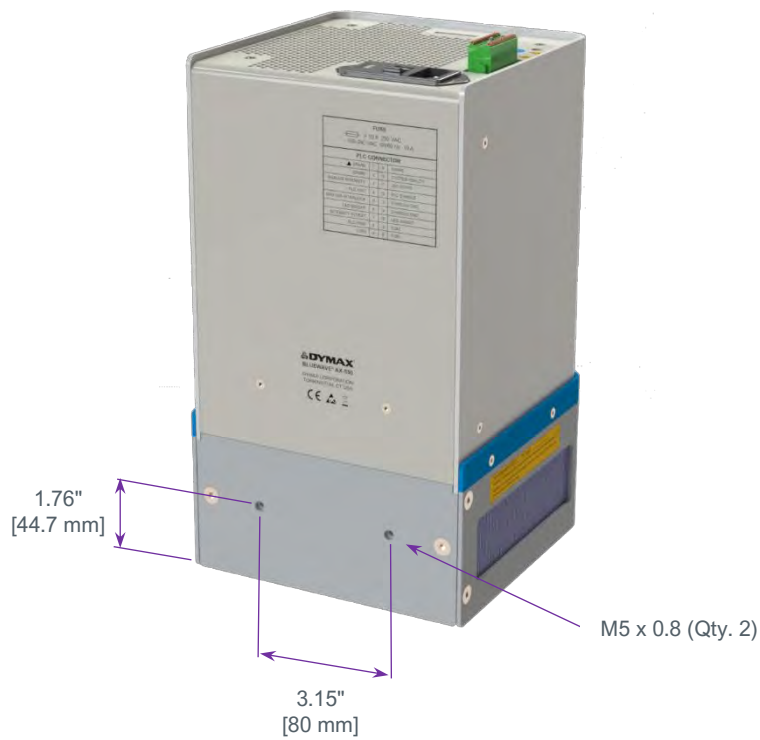

Table 5.
Operation Timing

Input Event	Out Event	Test Condition	Maximum Time Delay
LED ON/OFF Change to Low	UV LED ON	PLC Mode	20 ms
	LED STATE Output Change to LOW		25 ms
LED ON/OFF Change to High	UV LED OFF		30 ms
	LED STATE Output Change to High		40 ms
LED ON/OFF (Closed)	UV LED ON	Manual Mode	150 ms
	LED STATE Output Change to LOW		180 ms
LED ON/OFF (Open)	UV LED OFF		25 ms
	LED STATE Output Change to High		50 ms
LED ON/OFF Asserted (Change form Open to Closed)	UV LED ON	Timer Mode UV LED is OFF	140 ms
	LED STATE Output Change to Low		150 ms
	UV LED OFF	Timer Mode Before Timer expired UV LED is ON	140 ms
	LED STATE Output Change to High		160 ms

Validation

Tests should be conducted prior to production to determine the time and light intensity required to fully cure your resin. The following approaches may be used to validate the curing process.

Set Exposure Time, Determine Intensity

Users can specify a cure time and, through empirical testing, determine the intensity required to achieve a full cure. As with any manufacturing process, it is advisable to incorporate a safety factor.

Set Intensity, Determine Exposure Time

Users can specify light intensity and, through empirical testing, determine the exposure time required to achieve a full cure. As with any manufacturing process, it is advisable to incorporate a safety factor.

NOTE: *Dymax recommends intensities low at first to preserve LED life.*

Contact the Dymax Application Engineering Team for additional process support.

Control

Process validation confirms a minimum acceptable intensity. Users can then choose to operate at full intensity (using the excess intensity as an additional safety factor) or adjust the output to a specific intensity level. To ensure consistent and repeatable process results, intensity levels should be monitored with a radiometer. This enables users to identify light intensity changes and take corrective action (either adjusting the light intensity or performing maintenance).

Declaration of Conformity

Figure 57.

Declaration of Conformity - CE



EU Declaration of Conformity

Manufacturer:
Dymax Corporation
318 Industrial Lane
Torrington CT 06790, USA

Product description: Bluewave® AX-550 LED Flood Curing System
Model name(s): AX-550

This product complies with the following relevant Union Harmonization Legislation:

Applicable EU Directives:	Applicable Harmonized Standards:
Electromagnetic Compatibility Directive(2014/30/EU)	EN 55011:2016/A11:2020 EN 61000-3-2:2014 Class A EN 61000-3-3:2013 EN 61326-1:2013
Low Voltage Directive(2014/35/EU)	EN 61010-1:2010, AMD1:2019
RoHS Directive 2011/65 EU (2015/863)	EN IEC 63000:2018
Other Regulatory Compliance	Photo-biological Safety EN 62471:2008, Risk Group 3
USA: UL 61010-1:2012	With R:2015-07 + R:2016-04 + R:2018-11-16 + R:2018-11-21 + R:2019-07
Canada: CAN/CSA-C22.2 No. 61010-1:2012	With U1:2015-07 + U2:2016-04 + A1:2018-11

Declaration:
This declaration of conformity is issued under the sole responsibility of the manufacturer.
Signed for and on behalf of:

 4/17/2023 Torrington, CT
Name Date Location

Authorized Signatory:
Toby Trudeau
Engineering Manager, Equipment
Dymax Corporation
Torrington CT., USA





North America: +1 860.482.1010 | Europe: +49 611.962.7900 | Asia: +65.67522887
© 2021-2022 Dymax Corporation. All rights reserved. All trademarks in this guide, except where noted, are the property of, or used under license by Dymax Corporation, U.S.A.
Please note that most dispensing and curing system applications are unique. Dymax does not warrant the fitness of the product for the intended application. Any warranty applicable to the product, its application and use is strictly limited to that contained in Dymax's standard Conditions of Sale. Dymax recommends that any intended application be evaluated and tested by the user to ensure that desired performance criteria are satisfied. Dymax is willing to assist users in their performance testing and validation by offering equipment, part rental and leasing programs to assist in such testing and evaluation. Data sheets are available for valve controllers or pressure pots upon request.

www.dymax.com

Figure 58.

Declaration of Conformity - UKCA



UK Declaration of Conformity

Manufacturer:
Dymax Corporation
318 Industrial Lane
Torrington CT 06790, USA

Product description: Bluewave® AX-550 LED Flood Curing System
Model name(s): AX-550

This product complies with the following relevant UK Legislation:

Applicable UK Legislation: Electromagnetic Compatibility Regulations 2016	Applicable Harmonized Standards: EN 55011:2016/A11:2020 EN 61000-3-2:2014 Class A EN 61000-3-3:2013 EN 61326-1:2013
Electrical Equipment Safety Regulations 2016	EN 61010-1:2010, AMD1:2019
The Restriction of the Use of Certain Hazardous Substances in Electrical And Electronic Equipment Regulations 2012	EN IEC 63000:2018
Other Regulatory Compliance	Photo-biological Safety EN 62471:2008, Risk Group 3

USA: UL 61010-1:2012
Canada: CAN/CSA-C22.2 No. 61010-1:2012

With R:2015-07 + R:2016-04 + R:2018-11-16 + R:2018-11-21 + R:2019-07
With U1:2015-07 + U2:2016-04 + A1:2016-11

Declaration:
This declaration of conformity is issued under the sole responsibility of the manufacturer.
Signed for and on behalf of:

 4/17/2023 Torrington, CT -
Name Date Location

Authorized Signatory:
Toby Trudeau
Engineering Manager, Equipment
Dymax Corporation
Torrington CT., USA



www.dymax.com

North America: +1 860.482.1010 | Europe: +49 81 1.962.7900 | Asia: +65 67522887

© 2021-2022 Dymax Corporation. All rights reserved. All trademarks in this guide, except where noted, are the property of, or used under license by Dymax Corporation, U.S.A.
Please note that most dispensing and curing system applications are unique. Dymax does not warrant the fitness of the product for the intended application. Any warranty applicable to the product, its application and use is strictly limited to that contained in Dymax's standard Conditions of Sale. Dymax recommends that any intended application be evaluated and tested by the user to ensure that desired performance criteria are satisfied. Dymax is willing to assist users in their performance testing and evaluation by offering equipment trial rental and leasing programs to assist in such testing and evaluation. Data sheets are available for valve controllers or pressure pots upon request.

Warranty

From date of purchase, Dymax Corporation offers a one-year warranty against defects in material and workmanship on all system components with proof of purchase and purchase date. Unauthorized repair, modification, or improper use of equipment may void your warranty benefits. The use of aftermarket replacement parts not supplied or approved by Dymax Corporation, will void any effective warranties and may result in damage to the equipment.

IMPORTANT NOTE: DYMAX CORPORATION RESERVES THE RIGHT TO INVALIDATE ANY WARRANTIES, EXPRESSED OR IMPLIED, DUE TO ANY REPAIRS PERFORMED OR ATTEMPTED ON DYMAX EQUIPMENT WITHOUT WRITTEN AUTHORIZATION FROM DYMAX. THOSE CORRECTIVE ACTIONS LISTED ABOVE ARE LIMITED TO THIS AUTHORIZATION.

Index

Accessories, 33

Connections

- Connecting Foot Pedal, 13
- Connecting the Inhibit/Interlock PLC controls, 11
- Connecting the Power Cord, 11
- I/O Interface Summary, 10
- PLC UV Control, 14
- Status output, 15

Contact Information, 4

Declaration of Conformity, 37

Help, 4

Installation, 7

Maintenance

- Emitter Replacement, 29
- Product Cleaning, 29
- Replacing the Fuse, 30

Operation

- Irradiation in PLC mode, 27
- Irradiation in Production or Admin Mode, 26
- Irradiation Setup, 24
- System Initializing, 18

Optional Equipment, 33

Parts Included, 6

Product Overview, 5

Safety, 4

Spare Parts, 33

Specifications, 34

Support, 4

System Assembly

- Connections, 9
- System Cooling, 7
- Wiring and Connections, 8

System Screens

- Curing Time Screen, 25
- Power Level Screen, 25
- Settings Screen, 19

System Settings, 19

- Admin Only Settings, 21
- General Settings, 19
- Swapping between Admin and Production Mode, 23

Troubleshooting, 31

Unpacking, 6

Validation

- Control, 36
- Setting Exposure Time, Determining Intensity, 36
- Setting Intensity, Determining Exposure Time, 36

Warranty, 39

